

Efficient Cooking for One

Charlotte Brennand
Food Science Specialist



July 1995

FN 501

TABLE OF CONTENTS

Why Cooking More Instead of Less Will Make Your Life Easier	1
Containers for Freezing	1
Packaging Methods and Materials	2
Freezer Paper	2
Plastic Bags	2
Foil	3
Rigid Containers	3
Glass	3
Cooling and Freezing	3
Soup or Stew Ice Cubes	3
Freezing Individual Portions	4
Thawing and Reheating	4
Creative Cooking	4
General Rules	5
Nutrition Information	5
Baked Products	5
French Toast	5
Bran Muffins	6
Desserts and Sweets	6
Cakes	6
Cookies	6
Cheesecake	6
Cream Puffs	7
Pies	7
Fruits and Vegetables	7
Fruit	7
Berries and Cherries	7
Apples and Peaches	7
[Q] Quick Baked Apples	7
[Q] Pears with Orange Sauce	7
Vegetables	8

Dried Beans	8
Potatoes	8
[Q] Baked Potato Halves	8
[Q] Savory Carrots and Broccoli	8
Meats, Poultry and Fish	8
Cutting up a Whole Turkey	9
Turkey Breast	10
Turkey Legs	11
Freezing Raw Meat v.s. Cooked Meat	11
Meat Loaf	11
Beef Loaf	11
Alison's Meat Loaf	12
Midwest Bar-B-Q	12
Lasagna	12
[Q] Pizza	13
Beef and Barley	13
Savory Barley Filling	13
Beef Pie	14
Salmon Croquettes	15
Chicken Italiano	15
Soups and Stews	16
Chicken or Turkey Broth	16
[Q] Fast Fish Soup	16
[Q] Greek Lemon Soup	17
Caldillo (Mexican Stew)	17
Cheesy Vegetable Soup	17
Rice	18
Fried Rice	18
Barley-rice Pilaf	18
Sandwiches	19
[Q] Quesadillos	19
Broiled Crab Sandwich	19
Salads	19

Utah State University is an Equal Opportunity/Affirmative Action Institution

Issued in furtherance of Cooperative Extension work, Acts of May 8 and June 30, 1914, in cooperation with the U.S. Department of Agriculture, Robert L. Gilliland, Vice President and Director, Cooperative Extension Service, Utah State University. (EP/07-95/DF)

WHY COOKING MORE INSTEAD OF LESS WILL MAKE YOUR LIFE EASIER

Cooking for one person on a day in, day out basis is not especially rewarding. This is especially true for the person who gets home from work wanting to relax and not spend time fixing a meal. There are many very good TV dinners available in the grocery stores today. Fast food restaurants and delicatessens also provide food rapidly. In these cases you pay for someone else's labor; however, it may be worth it to you. On the other hand, you can make most meals for less money and the meals can be tailor-made to your personal likes, dislikes and diet needs. They are also available without leaving home.

The portioning out of individual servings and freezing for later can also be useful as a solution to special problems. Meals can be supplied to elderly or handicapped friends or relatives for them to heat at a later time. College students with access to a freezer compartment and a microwave might appreciate having ready meals that taste like home cooking during finals. Food can be specially prepared for family members with allergies or other special dietary requirements.

Some of the recommended procedures do take time, but they use less time per meal than cooking every meal from scratch. Many hearty, relatively economical dishes require long cooking times. These lend themselves to cooking in large portions and then freezing in smaller portions for later use. For a slight increase in work, you can have 6–10 servings of stew or soup for use later.

There are two approaches to building a supply of quick meals. Enough food can be prepared and frozen over a weekend to take care of the

rest of the month or the preparation of large quantities can be spread out over the month. Whenever you fix a food that lends itself to freezing, make extra.

There are economic benefits to cooking large quantities at a time. It is possible to take advantage of the normally lower price per pound for larger purchases. For example, a boneless chuck or rump roast will cost less than stew meat and can be cut into pieces for use in a variety of products. When consciously planning to preserve part of the food, there is less likelihood of spoilage problems since there are fewer leftovers in the back of the refrigerator. Money is also saved by not going to the grocery store as frequently, and thus there is less temptation for impulse buying.

Having prepared meals available lends itself to special need problems such as providing food to someone who will not or is not able to cook. Food can be prepared for special dietary needs.

This booklet will look primarily at freezing food as the means of simplifying food preparation for solo cooking; however, some other methods are also included.

Dishes that lend themselves to quick food preparation are marked [*Q*].

CONTAINERS FOR FREEZING

All containers and packaging materials used should be food grade. Plastics and foil sold for use with food or plastic cartons which previously held food can be used for freezing; however, not all plastics are heat stable and safe to use when reheating frozen food in a microwave oven. If you plan to take food directly from the freezer to the microwave, use containers sold as microwave safe.

PACKAGING METHODS AND MATERIALS

There are a number of different ways in which food can be packaged for storage. Your decision of which to use may be affected by the specific food product, packaging costs, packaging ease and package availability. The major objectives in packaging are to keep air from the product and minimize moisture loss from the product.

FREEZER PAPER

Food can be wrapped either before freezing or immediately after freezing with freezer paper. If the food is soft or runny in nature, it is best to freeze it first, then remove it from the container and wrap the frozen block. Frozen food can be returned to the same container for reheating if desired.

Freezer paper is the least expensive method per package but requires more work. Longer shelf-life can be obtained by wrapping with a good quality plastic (ex. Handiwrap or Saran) before over wrapping with the paper.

The two basic wrapping techniques are the butcher wrap and the drug store wrap.

Butcher Wrap

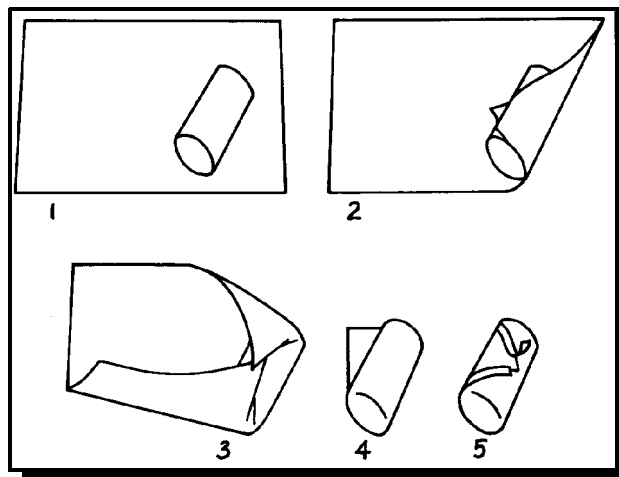

Drug Store Wrap

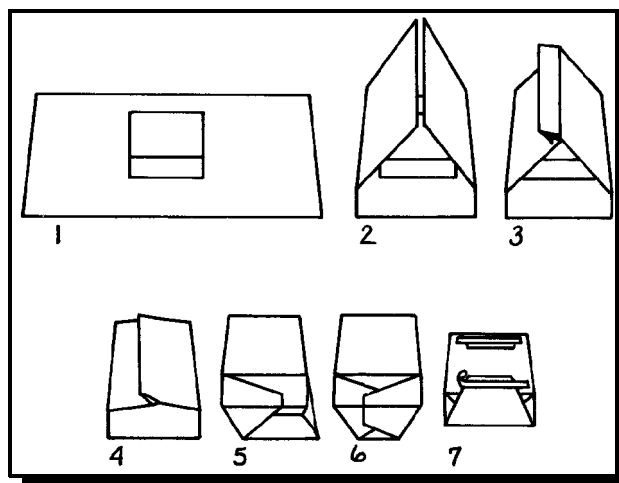

PLASTIC BAGS

Plastic bags should be made from a film with a relatively high mil thickness. Lighter weight bags do not provide adequate protection over time. Sandwich bags and bread bags are not recommended. An exception would be freezing bread for short time periods in the original bread bag. Plastic bags are one of the easiest materials to use. The food is placed in the bag, air pressed out and the bag sealed and labeled.

Devices that heat seal bags are widely available; however, decide how often you would use it before investing in one. Freezer plastic bags with a zip-closure are available in grocery stores. The zip-closure bags are slightly more expensive per bag than the plastic bags sold for use with a heat sealing device. Other types of freezer bags can be sealed by twisting the open end closed and tying with a metal twist or a rubber band. If the bag is partially tied off and then folded back on itself for the final tie, it will

make a better air barrier. The more air that is removed, the longer you can store the product and maintain quality.

For individually frozen portions, it is convenient to have the product in a container that can be opened to remove a portion and then resealed. Zip closure and tied bags work well in this case. Heat sealed bags can be sealed with extra length to allow for cutting off an end and then re-sealing. Plastic bags do not stack well in the freezer. This can be improved by stacking them in a bread pan or small box in the freezer.

FOIL

Food products can be wrapped in heavy duty aluminum foil, taking care to seal off the edges with a drug store wrap. Use masking tape to label. Avoid punching holes in foil.

RIGID CONTAINERS

Rigid sided plastic containers work very well, especially for soft or runny foods such as soup. Allow ½ inch headspace for expansion of the liquids during freezing. If the lid does not make an airtight seal, wrap freezer tape, masking tape or strapping tape around the joint. If food is to go from the freezer to the microwave, be sure to use a container that is microwave safe. Unless the container is specifically labeled as to being oven safe, do not reheat food in an oven. Never put the plastic container on a hot burner.

GLASS

Glass containers with good lids work well for freezing if expansion space is allowed below the shoulder of the jar. Allow at least ½ inch below the jar shoulder. Straight sided jars work best. Half-pint straight-sided jars for canning are especially good for individual portions and can safely be used for reheating in a microwave oven. Glass is a superior barrier to air and moisture movement.

COOLING AND FREEZING

Food should be cooled quickly to retard the growth of bacteria and to help retain the natural flavor, color and texture of the food. The portioning of the finished product into individual serving sizes prior to cooling will help the material cool more rapidly.

Freezer temperature should be 0°F or below. Spread the cartons or packages over the freezer shelf that has the cooling elements and allow 1-inch space around packages so that the food will freeze rapidly. The more rapidly the food freezes the better the quality of the food later.

The temperature at which the food is held in the freezer will affect how long the food can be held without loss of quality. The colder the freezer, the longer the storage time.

SOUP OR STEW ICE CUBES

A convenient method for handling soups, stews and other liquid mixtures is to make bowl shaped ice cubes out of them.

Cook the product, then transfer it to microwave safe bowls of the desired serving size. Freeze the product in the bowl overnight.



Run tap water over the back of the bowl until the frozen disk can be removed from the bowl. A slight twist on the disk helps.



Place the frozen disks of soup/stew into a plastic bag. Press out as much air as possible. Seal and return to freezer.



To use, place a frozen disk back into the bowl and microwave until hot.

FREEZING INDIVIDUAL PORTIONS

Freezing food so that it is easy to remove individual portions from the mass works very well for berries, vegetables, muffins, slices of pie, and cake.

Spread the food out on a cookie sheet so that it doesn't touch. Freeze overnight or until frozen solid then transfer the product to bags or other containers. The bag can be opened to remove the exact amount desired for use.

THAWING AND REHEATING

Products do not need to be thawed before heating.

Reheating times will vary with size of portion, freezer temperature, method of reheating and other factors such as wattage of microwave; thus, any times mentioned are only estimates. Products that have already been cooked need only to be reheated uniformly throughout.

Most products can be reheated in a variety of ways. Foods frozen in sealed bags can be reheated by placing in boiling water. Bread products and meats such as barbecued ribs can be heated in an oven or toaster oven. Toaster ovens are less expensive to run than standard sized ovens and are usually large enough for single servings. Most products can be reheated in a microwave oven. Do not leave bread products too long in a microwave; it will make them tough and dry. Soups and stews can also be heated in a sauce pan. Fried rice is best refried.

CREATIVE COOKING

From a safety aspect, there is much more flexibility when freezing products than when canning them. Feel free to experiment by combining a variety of products or adding seasonings based upon individual preferences. Some products do not freeze well. Boiled potatoes tend to be soggy; however, potatoes can be included in stew if their being slightly soggy is acceptable. Try a small batch initially to see if you will like the results.

GENERAL RULES

Do not freeze the following:

- ◆ mayonnaise, salad dressing*
- ◆ cream to be whipped unless it is the type that has mono and diglycerides added
- ◆ sour cream*
- ◆ yogurt*
- ◆ soft meringues
- ◆ lettuce or other fresh greens
- ◆ gravies*
- ◆ cream or custard pies
- ◆ hard-boiled eggs

*unless used in combination with other ingredients

The recommendation for not freezing certain foodstuffs is due to the effect on the quality of the product. For example, gravy, pudding and cream pie filling curdle when frozen and thawed. No food becomes toxic due to freezing.

NUTRITION INFORMATION

Nutrition information on selected nutrients is provided for recipes. The abbreviations used are as follows:

Cal =calorie content in grams

Pro = protein content in grams

Fat = fat content in grams

CHO = total carbohydrate content in grams

Chol = cholesterol content in milligrams

Iron = Iron content expressed as a percent of U.S. Recommended Dietary Allowance

Ca = Calcium expressed as a percent of U.S. Recommended Dietary Allowance

Vit A = Vitamin A expressed as a percent of U.S. Recommended Dietary Allowance

Vit C = Ascorbic acid expressed as a percent of U.S. Recommended Dietary Allowance

It is desirable to reach 100% of the Recommended Dietary Allowance for iron, calcium, Vit. A and Vit. C over the course of a day. Fat should be limited to no more than 30% of calories per day. This is about 67 grams for a 2000 calorie diet. Cholesterol should not exceed 300 mg per day.

BAKED PRODUCTS

Breads freeze very well. Specialty breads can be made up in small loaves or frozen in serving portions or individually frozen and then stored in the same plastic bag.

Any favorite bread, muffin, biscuit, coffee cake or cake recipe can be used. Double the ingredients and mix in the usual manner. You will need larger bowls than usual and may have to bake the products in batches instead of all at the same time. Portion into desired serving sizes and freeze.

FRENCH TOAST

7 eggs

2 ½ c. milk

1 loaf of bread

margarine or butter

Mix eggs and milk. Dip bread into egg mixture. Brown in fat until golden, turn, brown other side.

Spread cooked French toast on cookie sheets single layer. Freeze. Transfer to plastic bags. To reheat, place frozen slice in toaster oven or in microwave and heat.

Nutrients per serving

2 pieces = 1 serving

yield 10

Cal	Pro g	Fat g	CHO g	Chol mg	Iron	Ca - % USRDA -	Vit A	Vit C
213	10.1	6.2	28.5	135	9.2	12.4	6.6	0.9

BRAN MUFFINS

Preheat oven to 400°F. Grease muffin tins or use paper liners to cut down on cleaning time.

3 c. flour
2 tsp. salt
1 tbls. soda
5 c. bran
1 c. sugar
½ c. brown sugar
1 c. raisins or chopped dates or chopped apples
or chopped prunes or chopped apricots
4 eggs
3 c. sour milk or buttermilk
⅓ c. oil

Combine dry ingredients in a very large bowl.
Mix until uniform in appearance.

Soak dried fruit in a small amount of hot water if needed. Pour off excess liquid. The liquid can be used in place of part of the milk.

Blend eggs, milk and oil. Add fruit and liquid mixtures to dry ingredients. Mix just enough to moisten all ingredients.

Immediately fill muffin tins 2/3 full.

Bake for 20-25 minutes at 400°F.

Even if the muffins must be baked in two batches, fill the muffin tins immediately after mixing and let them sit while the first batch bakes. Since this recipe uses baking soda and sour milk, the leavening reacts rapidly and will be lost if the mixture is stirred after sitting. If enough muffin tins are not available, you may wish to use another recipe. Muffin batter can be baked in pie plates, then sliced into wedges. If baked in pie pans, decrease the oven temperature to 375°F and increase the baking time to 40 minutes. After baking, place the muffins on a tray and place in the freezer until frozen, or overnight. Transfer the muffins to plastic bags and force as much air as possible out of the bag,

seal and return to freezer. Since the muffins were individually frozen, you can later remove whatever number you wish from the bag.

Nutrients per serving

1 muffin = 1 serving yield 36

Cal	Pro g	Fat g	CHO g	Chol mg	Iron	Ca - % USRDA -	Vit A	Vit C
117	3.4	2.8	22.6	19	8.0	4.7	0.7	0.0

DESSERTS and SWEETS

Most traditional desserts can be portioned out for single servings.

CAKES

Cakes freeze very well either whole or in slices. Butter cream frostings, cooked type frostings (except chocolate fudge) and nut topping also freeze well. Whipped cream toppings are best added fresh after thawing the cake. Aerosol cans of whipped topping will keep in the refrigerator for several weeks.

COOKIES

Cookies have a relatively long storage life when held in a closed container at room temperature, but can be frozen for longer storage. Cookie dough can be frozen. Refrigerator or drop type cookie doughs are best handled by putting the dough on wax paper or plastic wrap and forming into a long cylinder. Wrap in foil and freeze. When ready to bake, slice frozen or thaw in the refrigerator and then slice the desired portions off the roll. Follow recipe recommendations for oven temperature and time.

CHEESECAKE

Prepare and bake cheese cakes as usual. Portion and freeze as individual servings. Wrap, label and return to freezer.

CREAM PUFFS

Cream puff shells freeze very well; however pudding or whipped cream fillings do not freeze well. Make cream puff shells as per recipe. Freeze individually on a cookie sheet. Place in a large plastic bag and remove as much air as possible. Seal and return to freezer.

To use shells, thaw and reheat if there is any moisture on the shell. Fill with chicken salad, ham salad, pudding, whipped cream, ice cream or filling of choice.

PIES

Make fruit pies using any recipe. When the pie has cooled, divide into the desired number of servings and place these on wax paper on a cookie sheet far enough apart so they do not touch. Freeze overnight or until solid. Place the slices in individual plastic bags, or in one large bag. Push out as much air as possible, seal and return to freezer. To use, transfer still frozen slice of pie to a plate and thaw at room temperature or in the microwave.

Cream pies made with cornstarch as the major thickener do not freeze well. Freezing results in a pie with a curdled appearance. If you wish to make starch thickened pies for the freezer, best results are achieved by adding Instant Clear Jel starch in the place of cornstarch. Instant Clear Jel can sometimes be found in specialty food stores and some grocery stores. This modified cornstarch does not curdle during freezing. To avoid lumps, be sure to blend the Instant Clear Jel with the sugar before adding liquid.

FRUITS and VEGETABLES

Individually freezing fresh produce makes it easier to take only what you want from a container at a later time. The basic procedure is to pretreat the product if necessary, then spread

it on a tray or cookie sheet and freeze it. Afterward transfer the product to a plastic bag or container and return it to the freezer. If your freezer fluctuates very much in temperature, with time the product will weld together. If this is a problem, freeze in small portions instead of storing the individually quick frozen pieces together in a large bag.

FRUIT

BERRIES AND CHERRIES

Wash, let drain and then spread on a cookie sheet. Freeze. Once frozen, transfer to a plastic bag or other container for holding.

APPLES AND PEACHES

Peel, slice and sprinkle with a commercial ascorbic acid mixture or dip in an ascorbic acid solution (1 teaspoon ascorbic acid per quart of water). Freeze as individual slices.

[Q] QUICK BAKED APPLES

Wash and core one apple. Put in small casserole dish and fill center with mixture of 2–3 tablespoons brown sugar and ¼ teaspoon cinnamon. Top with a pat of margarine. Microwave 5 minutes or until tender.

[Q] PEARS WITH ORANGE SAUCE

½ c. orange juice
1 tbsp cornstarch
¼ c. sugar
1 pear

Mix sauce ingredients and simmer 2–3 minutes.

Slice pear lengthwise into thin slices. Pour hot orange sauce over and serve.

Nutrients per serving

1 serving = 1 pear yield 1

Cal	Pro g	Fat g	CHO g	Chol mg	Iron	Ca	Vit A	Vit C
- % USRDA -								
377	1.5	0.7	95.6	0.0	3.4	3.0	2.6	91.6

VEGETABLES

Wash, blanch and freeze individually or in small portions, or buy commercial vegetables that have been individually quick frozen. Canned vegetables can be purchased in single-serving size cans.

DRIED BEANS

Most types of dried beans require a long cooking process. This makes them especially good candidates for cooking large batches and freezing in individual portions. Prepare dried beans using any preferred recipe. Portion into servings and freeze.

POTATOES

Mashed potatoes and hash browned potatoes retain their quality during freezing. Boiled potatoes turn out mushy. Pre-baked potatoes do not provide a time saver since reheating a still frozen potato takes as long as baking, and they tend to have a warmed-over flavor.

[Q] BAKED POTATO HALVES

Slice potatoes in half lengthwise. Place cut side down on buttered pan and bake at 425°F for about 30 minutes. Cut side of potato can be sprinkled with herbs prior to baking.

[Q] SAVORY CARROTS AND BROCCOLI

Peel and slice carrots. Trim tough portions from broccoli stalks and cut stalk into rounds. Simmer carrots, broccoli heads and broccoli

stalk pieces until tender in 1 cup chicken broth (canned or 1 chicken bouillon cube in 1 cup water), 1 teaspoon basil, and 1 tablespoon margarine.

MEATS, POULTRY and FISH

One of the problems with purchasing food when cooking for one is that fresh meat packages usually contain more meat than is desirable for a single person. It is also cheaper per pound to buy larger quantities of meat. The solution to this is to buy the larger packages of meat and then portion them into the desired sizes.

However, when evaluating the price saving per pound of meat when purchased in large quantities be sure to include repackaging costs.

Do not freeze fresh meats in the packages that they are sold in if you wish to hold them more than 1–2 weeks in the freezer. The film over fresh meat is made to allow oxygen to reach the meat since this keeps it a nice, bright red. However, the presence of air with frozen food will lead to freezer-burn and rancidity. Wrap the meat in a plastic overwrap and freezer paper, or seal in plastic bags for freezer storage. Removal from the grocery store package prior to rewrapping is optional.

Whole chicken is usually cheaper per pound of boned-out meat than packages of chicken parts; therefore, **if** you will use all of the cuts of chicken, buy the whole chicken. Chicken breasts with bone and skin are less expensive per pound of boned-out meat than the boneless, skinless chicken breasts. Chicken pieces can be individually frozen and then all stored together in a plastic bag or portioned out into several small containers.

Whole turkeys can be purchased and then cut into desired portions. If the turkey is purchased frozen, you can request the grocery store

butcher to cut it in halves or quarters. Turkeys may be safely thawed and refrozen if care is taken. The bird should be thawed in the refrigerator and cut up while it still has some ice crystals in the cavity but is thawed enough to move the legs easily.

A whole turkey seems like a large, unusable portion of meat when cooking for one; however, consider the following possible uses. Thaw a 20 pound turkey enough to allow it to be cut into portions. First, cut the leg-thigh sections off at the thigh joint. Remove wings. Cut breast portion from back. Cut breast into two major portions. Roast one portion of the breast for supper and use leftover breast for turkey sandwiches or turkey salad the next day. Bone the other breast and cut into turkey steaks. Boil the back portions, wings and neck for soup stock and cooked turkey which can then be used in casseroles, Brunswick stew, turkey enchiladas or soup. Freeze the legs and thighs and other breast portion individually for later use. Consider making a few packages of meat strips for use in stir fry dishes.

Following are diagrams of how to cut up a turkey. Illustrations are provided by the National Turkey Federation.

CUTTING UP A WHOLE TURKEY

1. Lay turkey on its back on cutting board with neck cavity facing away. Remove giblets, neck, clip, and tail.

2. Remove metal clip by pulling clip away from turkey legs, then lift legs from clip one at a time. Squeeze clip to release hooks from back bone and remove.

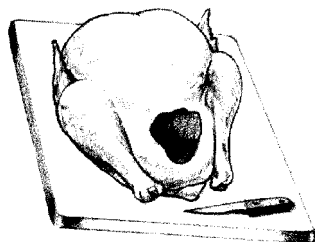

3. Pull tail out of body cavity and cut it off.

Cut off wings

4. Roll turkey on its side, then forcefully pull the wing away from the body. Cut into the hollow between the breast and wing.

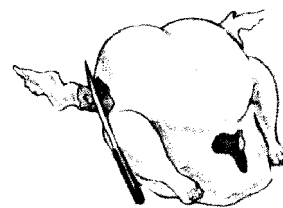

5. Continue pulling the wing away from the body. Cut around wing joint.

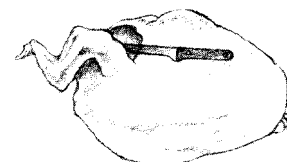

6. Bend wing back, exposing the joint. Cut through. Repeat for other wing.

Cut wing into segments

7. Separate wing into three parts: Slice skin around joint at the small bony end. Bend back, exposing joint and cut through.

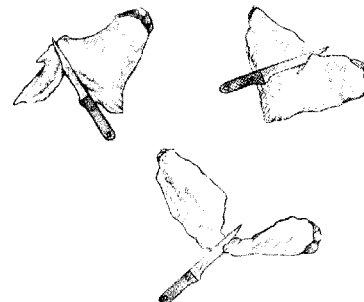

8. Cut through skin and slice skin around next joint.

Remove drumstick and thigh

9. Cut through skin between the breast and thigh.

10. Cut down to the joint where thigh connects to back.

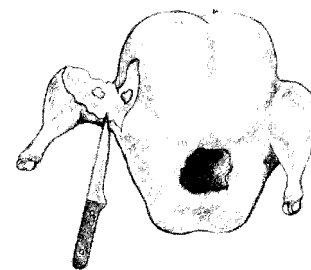

11. Push on drumstick and thigh to open joint at the back bone and cut through.

12. Repeat for other leg.

Cut drumstick from thigh

13. Find the natural fat line between the drumstick and thigh then pull skin tightly over top of leg, feeling for a small indentation to find the joint.

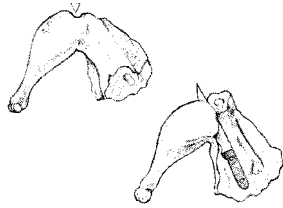

14. Lay thigh skin side down and, following above guides, cut through joint, bending drumstick back gently while cutting.

Cut back from breast

15. Stand turkey up on neck joints and locate cartilage line running down ribs.

16. Separate back into two parts by counting two ribs in from tail and cutting through the natural joint.

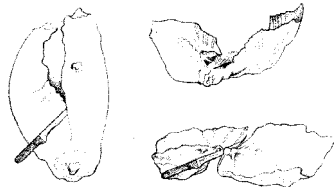

17. Cut down ribcage to neck joints on both sides, bending the two parts away from each other to expose the joints.

18. Cut through shoulder joints on each side and cut through skin, separating breast and backbone.

TURKEY BREAST

Turkey breasts can be left whole to use for roasting at a later time or cut in half with bone still attached. Alternately, the breast can be boned-out and cut up as shown in the following diagrams.

Cutting Tips

- ◆ Work on sanitized cutting surface
- ◆ Be sure hands and knives are clean and sanitized
- ◆ Use a sharp knife. Knife could be a boning knife, short knife or medium chef's knife.
- ◆ Turkey should be very cold and slightly stiff for easier cutting.
- ◆ Cover and refrigerate parts as soon as they have been cut.

Skinning and boning the breast

1. Cut membrane between skin and meat. Pull off skin.

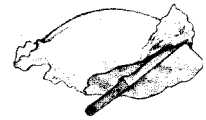

2. Start at neck cavity and cut along top edge of breast bone.

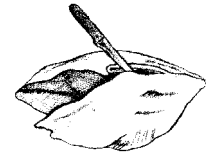

3. Cut along edge of wishbone and keelbone, peeling breast from bones, leaving as little meat on the bones as possible.

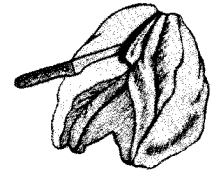

4. Remove half-breast and repeat for other side.

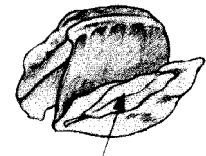

Cutting steaks and slices/cutlets from the breast

1. Cut steaks by slicing half breast across the grain into ½ to 1 inch thick steaks.



2. Cut slices or cutlets by slicing half breast across the grain into 1/8 to 1/3 inch thick cutlets.

TURKEY LEGS

Turkey legs may be left as the whole drumstick-thigh for roasting later, or cut into drumstick and thigh portions as shown in steps 13 & 14 on previous page. Thigh portions may be boned out.

Boning the thigh

The turkey thigh is easy to debone. Turkey thigh meat can be used in any recipe or preparation calling for beef chuck or round, or the boned thigh may be stuffed.

1. Place the thigh skin-side down. Cut down to the bone, then along the full length of the bone.

2. To free the ends, slip the knife under the bone halfway down its length.

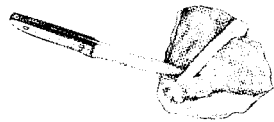

3. Cut away from hand, freeing one end of the bone from the flesh.

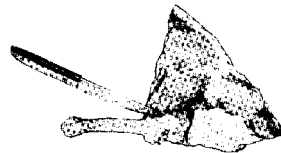

4. Turn the thigh around, lift the free end of the bone with one hand, and cut the other end free.

5. Reserve the bone for stock.

FREEZING RAW MEAT v.s. COOKED MEAT

Beef, pork and poultry that have been roasted can be sliced and frozen for use later; however, plan to use it in a short period of time since it will not keep as long as it would in the raw form. This is due to changes in the fat which will affect the flavor. There are compounds in some foods which will slow down these undesirable changes, thus extending the length of time products can be stored. Examples of

foods that will extend the freezer storage life of cooked meats include bell peppers, green chile peppers, orange juice and pineapple. Simply freezing the cooked meat immersed in gravy or broth will extend freezer shelf-life by a month.

MEAT LOAF

Meat loaves may be frozen raw or cooked first. Use your favorite recipe or the following recipes. If you use fresh onion and plan on freezing it raw, saute the onions before mixing with the meat.

To freeze cooked meat loaf—Cool for 30 minutes at room temperature. Remove from pans. Slice into serving pieces. Place on freezer wrap or foil. Allow enough extra wrap to fold over top. Fold and seal wrapping. Label and freeze immediately.

An alternate method is to portion and freeze individual slices on a cookie sheet. Once frozen, stack slices in a plastic bag.

To heat frozen slices—If frozen in foil, put in oven or toaster oven as is, otherwise remove freezer wrap and place beef slice in baking pan. Heat at 375°F for 20 minutes or until hot throughout. Slices may also be heated in a microwave oven in a covered container.

To freeze raw meat loaf—Portion meat loaf mixture into individual size, ovenproof containers (small loaf pans, custard cups, small casseroles). Cover with foil and freeze.

To cook frozen raw meat loaf—Unless the portion is small, it is best to thaw the meat loaf before cooking. Follow recipe cooking instructions for meat loaves.

BEEF LOAF

2 large eggs, slightly beaten
1 1/3 c. milk
6 slices bread, diced

1/8 c. instant minced onion
 1/2 c. finely chopped celery
 2 tsp. salt
 1/4 tsp. pepper
 1/2 c. catsup
 2 tsp. Worcestershire sauce
 3 lbs. ground lean beef

Mix eggs and milk.

Add remaining ingredients except meat. Beat well.

Mix in meat lightly.

Divide mixture into desired portions. The mixture will make three medium loaves (3 cups per loaf) or nine small loaves. Bake at 325°F for 45-60 minutes or until loaf is done.

Nutrients per serving

1 serving = 1 slice yield 12

Cal	Pro g	Fat g	CHO g	Chol mg	Iron	Ca - % USRDA -	Vit A	Vit C
374	23.5	25.4	10.9	128	14.2	6.2	5.6	5.3

ALISON'S MEAT LOAF

2 lbs. lean hamburger
 2 tsp. salt
 1 medium chopped onion
 1 green pepper, chopped
 4 slices bread
 2 eggs
 4 tsp. Worcestershire sauce
 1/2 tsp. coarse black pepper
 milk
 catsup

Sprinkle salt over hamburger. Mix in onions and green pepper.

Mix bread, egg, Worcestershire sauce and pepper with enough milk to make the bread mushy.

Combine meat and bread mix. Shape into small individual loaves or two large loaves. The miniature meat loaves can also be shaped and frozen in custard cups or any ovenproof container. Sprinkle catsup on top and spread over surface. Freeze. Bake fresh or thawed loaf at 350°F for 45-60 minutes depending on size.

Nutrients per serving

1 serving = 1 slice yield 8

Cal	Pro g	Fat g	CHO g	Chol mg	Iron	Ca - % USRDA -	Vit A	Vit C
401	26.7	23.0	20.6	133	18.6	11.3	14.6	58.9

MIDWEST BAR-B-Q

4 lbs. beef roast
 4 lbs. pork shoulder roast
 32 oz. bottle catsup
 1/4 c. vinegar
 2 whole onions
 Tabasco sauce to taste (4-5 shakes)
 2 tbs. prepared mustard
 1/2-3/4 c. brown sugar
 2-3 tbs. pickling spices (tied in cheesecloth)

Cover with water in saucepan and cook meat until it falls apart.

Shred meat and remove fat and bone. Strain broth. Put meat in a large kettle and pour broth over it to cover.

Add remaining ingredients to meat. Mixture will look pale; cook 1 1/2- 2 hours (final mixture will be a darker red).

Portion meat, cool and freeze.

Nutrients per serving

1 serving = 4 oz. cooked meat yield 24

Cal	Pro g	Fat g	CHO g	Chol mg	Iron	Ca - % USRDA -	Vit A	Vit C
530	36.7	35.6	13.7	138	17.7	2.9	10.7	11.1

LASAGNA

1 pound ground beef
 ½ c. chopped onion
 1 (28-oz.) can tomatoes
 1 (6 oz.) can tomato paste
 1 tsp. dried oregano leaves
 ½ tsp. dried basil leaves
 1 tsp. garlic salt
 1 12 oz. pkg. lasagna noodles
 1 lb. carton creamed cottage cheese
 1 tbs. dried parsley
 2 eggs
 8 oz. shredded Mozzarella cheese

Brown beef lightly in skillet. Add onion and brown. Pour off fat. Add tomatoes and seasonings and simmer for 15-20 minutes.

Cook noodles in boiling water until tender.

Beat eggs with a fork until mixed. Add cottage cheese and parsley. Mix.

Layer noodles, meat-tomato mixture, cottage cheese mixture in 9 x 13 baking pan or dish. Top with Mozzarella cheese.

Bake 30-35 minutes at 350°F until bubbly. Let stand for a few minutes before cutting. Portion and freeze. When solid, wrap and label. Will yield eight servings.

Nutrients per serving

1 serving = 4 x 2 in. piece yield 8

Cal	Pro g	Fat g	CHO g	Chol mg	Iron	Ca - % USRDA -	Vit A	Vit C
358	27.4	20.1	16.5	113.1	15.6	26.8	32.9	40.6

[Q] PIZZA

Buy a large pizza, or two, if the price is better. Enjoy part while hot. Slice and separate slices slightly on a cookie sheet. Freeze. Transfer frozen slices to a plastic bag for freezer storage.

Reheat unwrapped in oven or toaster oven at 425°F.

BEEF AND BARLEY

2 lbs. of beef cubes
 2 tbs. of oil
 2 c. water
 1 tablespoon salt
 ¼ teaspoon black pepper
 ⅔ c. pearl barley
 4-5 c. water
 2 c. chopped onions
 ½ lbs. of sliced mushrooms (optional)

Brown beef cubes in oil. Add water and simmer for 1 hour.

Add seasoning, barley and water. Simmer for 30 minutes. Add more water if needed.

Add onions and mushrooms. Simmer 5-10 minutes.

Portion into individual servings, let cool 15 minutes and freeze.

Nutrients per serving

1 serving = 3 oz. meat yield 10

Cal	Pro g	Fat g	CHO g	Chol mg	Iron	Ca - % USRDA -	Vit A	Vit C
346	15.6	25.4	15.7	56	18.1	2.64	0.9	4.9

SAVORY BARLEY FILLING

(for stuffed vegetables)

1 16-ounce can stewed tomatoes
 ⅔ c. pearl barley
 ½ tsp. ground cumin
 1 tbs. olive or vegetable oil
 1 large onion, chopped
 2 cloves garlic, chopped
 ½ pound lean ground beef or turkey
 ¾ tsp. ground allspice
 ¼ c. chopped parsley
 ¾ tsp. salt

¼ tsp. pepper
6 medium bell peppers or 4 large bell peppers

Drain tomatoes in sieve over 2-cup measure; reserve juice. Add water to juice to make 2 cups. Place in saucepan and add barley and cumin. Simmer 40-45 minutes or until liquid is absorbed. Add drained tomatoes.

Heat oil in skillet. Add onion and garlic; saute until golden. Add ground beef and allspice. Cook until meat is no longer pink. Add to barley mixture with parsley, salt and pepper.

Slice stem ends from medium bell peppers, remove seeds. Or, halve large green peppers and remove seeds. Place in plastic bag or casserole dish with 2-3 tablespoons of water and microwave on high for 3-4 minutes or parboil in boiling water for 4-5 minutes. Drain well.

Fill peppers with Savory Barley Filling. Place in casserole or baking dish. Pour ½ cup liquid (chicken broth, beef broth or water) in casserole with barley-stuffed peppers. Cover and bake in 350 F oven 30-35 minutes. Remove cover, sprinkle grated Cheddar or Parmesan cheese over tops of peppers. Freeze individual portions. If you wish to bake one for dinner, cook it 5 minutes longer.

To reheat, microwave frozen peppers in covered container until hot.

Nutrients per serving

1 serving = 1 pepper yield 6

Cal	Pro g	Fat g	CHO g	Chol mg	Iron	Ca	Vit A	Vit C
- % USRDA -								
249	10.7	10.9	29	28	16.9	5.4	18.9	183.4

BEEF PIE

Line small loaf baking pans with heat-resistant freezer wrap or foil. Allow enough extra wrap to fold over top. Use one pan for each six servings or one-fourth of the recipe. Do not line pans for food to be served immediately.

Filling:

3 c. onions, quartered
2 c. boiling water
½ c. oil, butter or margarine, melted
1 c. unsifted flour
1 tbs. salt
¼ tsp. pepper
1½ qts. onion cooking liquid and water.
1 tsp. gravy seasoning, if desired.
4 c. cubed cooked beef
2 10 oz. packages frozen green peas

Cook onions in boiling water until tender. Drain; save cooking liquid. Stir flour, salt and pepper into oil. Stir liquid into fat-flour mixture. Add gravy seasoning. Cook until thickened, stirring constantly.

Pour sauce over onions, peas and beef. Mix gently. Pour one fourth of mixture into each baking pan.

Yield: 24 servings, about 2/3 cup filling each

Crust

2 c. unsifted flour
1 tsp. salt
¾ c. margarine
¼ c. cold water

Mix flour and salt. Cut in fat only until mixture is crumbly. Add water and mix lightly.

Divide dough into parts. Roll each part out on lightly floured surface cut to fit over filling in pans. If desired, sprinkle each pan with ¼ tsp. poppy seeds.

To Serve Without Freezing:

Preheat oven to 450°F.

Bake 45 minutes or until crust is lightly browned.

To Freeze:

Cool for 30 minutes at room temperature.

Fold and seal wrapping. Label and freeze immediately.

To Heat Frozen Beef Pie:

Preheat oven to 450°F.

Remove freezer wrap. Place food in baking pan.

Bake 1 hour or until filling is bubbly at edges, crust is lightly browned, and food is hot in center.

Nutrients per serving

1 serving = 2/3 cup yield 24

Cal	Pro g	Fat g	CHO g	Chol mg	Iron	Ca - % USRDA -	Vit A	Vit C
274	8.8	19	17.8	23	12.3	2.2	11.3	6.2

SALMON CROQUETTES

1 can (15½ oz.) salmon, drained, flaked

2 eggs, slightly beaten

1½ c. cracker crumbs (separated)

½ c. finely chopped onion

3 tbs. finely chopped parsley

2 tbs. lemon juice

¼ tsp. salt

⅛ tsp. pepper

Mix together salmon, eggs, 1 c. cracker crumbs, onion, parsley, lemon juice, salt and pepper until well blended.

Shape into patties about 3 in. wide and ¾ in. thick. Coat with remaining cracker crumbs.

Cook patties desired for immediate consumption and freeze the remainder. Once frozen, transfer from plate to a freezer bag and return to freezer.

To cook, heat a small amount of oil in a skillet over medium heat and cook for about 10 minutes, turning once. For later use, either thaw and cook as above or fry in frozen state, taking care not to burn outside before the patty is heated throughout.

Nutrients per serving

1 serving = 1 patty yield 8

Cal	Pro g	Fat g	CHO g	Chol mg	Iron	Ca - % USRDA -	Vit A	Vit C
167	14.2	6.2	12.5		46	7.7	13.7	7.2

CHICKEN ITALIANO

4 skinned, boned chicken breasts

1 tsp. olive oil

4 oz. (about 1½ c. dry) thin spaghetti, broken into fourths

1 small onion, cut in wedges

1 green pepper, cut in strips

1 clove garlic, minced

1 tsp. oregano

⅛ tsp. salt

⅛ tsp. pepper

1 bay leaf

16 oz. can tomatoes

Pound chicken breasts with meat mallet in zip-lock plastic bag until about ½ inch thick.

Heat oil in a non-stick pan. Brown chicken breasts on each side.

Add spaghetti, onion and pepper strips around chicken. Sprinkle with seasonings.

Break up large pieces of tomatoes. Pour tomatoes and water over top of chicken. Bring to boil.

Reduce heat, cover, and cook until chicken and spaghetti are done, about 15-20 minutes.

Remove bay leaf. Garnish with 1 tablespoon chopped fresh parsley. If the sauce seems too soupy at the end of the cooking time, stir in one

6-ounce can of tomato paste. Divide into four portions and freeze.

Serving suggestion: Serve with a spinach salad dressed with low-cal vinaigrette sauce and garnished with mandarin oranges.

Nutrients per serving

1 serving = 1 breast yield 4

Cal	Pro g	Fat g	CHO g	Chol mg	Iron	Ca - % USRDA -	Vit A	Vit C
218	11.6	5.3	31	14	12.1	5.3	17.4	70.1

SOUPS and STEWS

Soups and stews are especially good for portioning out for future meals. They can be made in large quantities from a variety of ingredients and as one dish meals insure that vegetables are included in the meal.

Some vegetables, including potatoes and carrots, tend to become mushy when frozen. This problem is not as noticeable with onions, celery, peas, broccoli, bell pepper, stewed tomatoes and mushrooms. Canned water chestnuts retain their crisp crunch and dried black mushrooms (tree fungi found in Oriental groceries) remain chewy-crisp during freezing. The importance of textural properties varies between people; therefore, if you want to include potatoes, do so, but don't make a huge batch until you know how well you will like the final product after thawing. White or brown rice, barley, bulgar or pasta can be used in the place of potatoes.

Canned or homemade broth (frozen or canned) is a basis for several quick soups.

CHICKEN OR TURKEY BROTH

Making your own broth can save money, provide a use for less desirable pieces of chicken or turkey, and allow you to control the amount of salt that is in the final product.

Simmer wings, backs, and necks in enough water to cover until the meat falls off the bones easily (1-2 hours). If your pan has a tight fitting lid, it is not necessary for all of meat to be submerged; steam will heat the part above water. Electric woks and electric saucepans work well for this step, but any large pan can be used.

Remove meat pieces from broth and let cool until they can be handled comfortably. Separate meat from bones and skin. Meat can be used in another dish or returned to broth for use with broth.

Skim excess fat from surface of broth if desired. Season as desired. Transfer to freezer cartons or jars. Label and freeze. When the broth is to be thawed at a later time, the chilled layer of fat on the surface can be removed.

[Q] FAST FISH SOUP

- fish fillet or shelled shrimp
- ½ carrot
- ¼ small zucchini
- ¼ bell pepper
- 1-2 green onions
- 1 c. chicken broth

Slice vegetables into very thin strips. Place fish, vegetables and broth in a microwaveable bowl. Microwave for 2-3 minutes or until fish is cooked.

Alternate method: Simmer ingredients in small saucepan for 3-4 minutes or until fish is cooked.

Nutrients per serving

1 serving = 1 bowl

yield 1

Cal	Pro g	Fat g	CHO g	Chol mg	Iron	Ca	Vit A	Vit C
- % USRDA -								
165	24	3.6	8.2	40	11.6	8.4	209.2	57.1

[Q] GREEK LEMON SOUP

1½ c. chicken or turkey broth

½ c. cooked chicken pieces

½ c. cooked rice

2–3 tbs. lemon juice

1 egg, beaten

Combine broth, chicken, rice and lemon juice.
Bring to a boil. Remove from heat.

Slowly add egg while stirring continuously.
Reheat slightly. If overheated, it will curdle.

Nutrients per serving

1 serving = 1 cup

yield 4

Cal	Pro g	Fat g	CHO g	Chol mg	Iron	Ca	Vit A	Vit C
- % USRDA -								
132	29.6	22.0	3.4	98	20.7	2.7	1.4	8.2

CALDILLO (MEXICAN STEW)

This dish is on the hot side. Ingredient proportions may be adjusted to individual tastes.

3–4 lbs. chuck or blade roast, cubed

1–2 tbs. shortening or oil

1 tbs. salt

3–4 c. water

2–3 medium onions

1 tsp. cumin seeds

4 oz. can diced green chile (not Jalapeno)

1 tbs. garlic powder

Brown the meat in fat. Add water and salt and simmer until tender. A pressure cooker will speed up the process. Add more water as

needed. You should end up with about 2 c. liquid.

Cut the onions into sections. Add onions to meat and cook 15–20 minutes. Add chile and seasonings to meat mixture.

Portion final mixture into either boil in bag containers or plastic cartons or glass jars. Seal, label and freeze. Serve with bread or flour tortillas.

Nutrients per serving

1 serving = 4 oz cooked meat

yield 12

Cal	Pro g	Fat g	CHO g	Chol mg	Iron	Ca	Vit A	Vit C
- % USRDA -								
337	29.6	22.0	3.4	98	20.7	2.7	1.4	8.2

CHEESY VEGETABLE SOUP

½ c. butter or margarine

3 c. sliced carrots

2 c. diced celery

½ c. diced green onions, discard dark green tops

½ c. flour

8 c. chicken broth, divided

2 c. milk

1 10 oz. package broccoli, frozen, chopped

16 oz. shredded Cheddar cheese

1 tbs. lemon juice

4 drops hot pepper sauce

½ tsp. salt

¼ tsp. white pepper

In a large saucepot, saute carrots, celery, and onion in butter until transparent.

Stir in flour; cook 1 minute. Gradually add ½ c. chicken broth and milk. Cook broccoli in ½ c. chicken broth.

Add broccoli and remaining ingredients to soup mixture. Continue cooking until heated thoroughly. Carefully ladle into containers; cool slightly and freeze.

Yield: about 5½ pints.

Nutrients per serving

1 serving = ½ pint yield 11

Cal	Pro g	Fat g	CHO g	Chol mg	Iron	Ca - % USRDA -	Vit A	Vit C
317	15.8	23.3	11.8	66	8.1	34.5	236.5	35.1

RICE

Instant rice is a time saver; however, if you prefer the texture of regular, converted or brown rice, consider freezing cooked rice. A large batch of cooked rice can be subdivided into portions to be frozen plain or part can be used to make fried rice.

FRIED RICE

- 4 c. cooked rice
- 3 tbs. oil
- 1 c. chopped green onion
- 1 bell pepper, chopped
- 2 c. diced ham
- 2 eggs
- pepper to taste

Saute onion, bell pepper and ham in 1 tablespoon oil in a large skillet until onions are limp. Transfer half of the mixture to a bowl. Add 1 tablespoon oil to skillet. Add 2 cups of cooked rice and 1 egg to sauted mixture in skillet. Stir mixture over heat until egg sets, about 5 minutes. Transfer to containers for freezing. Repeat the process with the material in the bowl, 1 tablespoon oil and the remaining 2 cups of rice and 1 egg to skillet.

Optional ingredients:

- Diced pork, chicken, turkey or shrimp
- Finely diced ginger root
- Finely diced garlic

Reheating: Individual portions can be reheated in a microwave, by immersion in boiling water if in a boilable plastic bag, or by refrying in a small amount of oil in skillet.

Nutrients per serving

1 serving = ¾ cup yield 6

Cal	Pro g	Fat g	CHO g	Chol mg	Iron	Ca - % USRDA -	Vit A	Vit C
292	9.8	9.7	40.2	72	12.6	3.6	3.3	31.9

BARLEY-RICE PILAF

- ⅓ c. quick-cooking barley
- ¼ c. uncooked brown rice
- 1⅔ c. hot water
- 1 c. sliced fresh mushrooms
- ¼ c. (¼-inch cubes) carrot
- 2 tbs. snipped fresh parsley
- 1 clove garlic, minced
- 1 tsp. lemon juice
- ½ tsp. dried thyme leaves

Combine all ingredients in 2-quart casserole. Mix well. Cover. Microwave at high for 5 minutes. Reduce power to 50% (medium). Microwave for 35 to 45 minutes longer, or until liquid is absorbed and rice is tender. Let stand, covered, for 5 minutes.

Nutrients per serving

1 serving = 1 cup yield 4

Cal	Pro g	Fat g	CHO g	Chol mg	Iron	Ca - % USRDA -	Vit A	Vit C
71.5	2.3	0.5	14.9	0.0	5	1.2	34	5

SANDWICHES

Sandwiches are the staple fast meals for many people. For variation, consider: strips of bell pepper in the place of lettuce, broiling an open face sandwich, changing types of dressing, and use of different breads.

[Q] QUESADILLOS

Place slices of cheese on a corn or flour tortilla. Sprinkle taco sauce or green chile on top of cheese if desired. Cover with second tortilla. Microwave to melt cheese or heat in dry skillet. If heating in skillet, turn quesadillo over after a minute or so.

[Q] BROILED CRAB SANDWICH

1 English muffin
3 oz. surimi (imitation crab)
¼ c. mayonnaise
1 green onion, finely chopped
1 stalk celery, finely chopped
1 oz. processed grated cheese
salt and pepper as desired

Cut English muffins in half. Combine surimi, mayonnaise, onion, celery, salt and pepper. Spread on muffin halves. Heat in microwave or under broiler. Top each half with grated cheese and broil until cheese is melted.

Nutrients per serving

1 serving = 1 sandwich yield 1

Cal	Pro g	Fat g	CHO g	Chol mg	Iron	Ca	Vit A	Vit C
- % USRDA -								
555	25.6	31.1	43.7	82	14.7	31.2	36.6	23.5

SALADS

FRESH SALADS

Salads made from fresh produce do not lend themselves to freezing; however, some short term early preparation is possible. Celery sticks, carrot sticks, and flowerettes of cauliflower or broccoli can be prepared and kept in a plastic bag in the refrigerator for several days.

Cabbage salads will keep longer than lettuce salads.

Lettuce salads will keep longer if the dressing and seasonings are not added ahead of time.

